

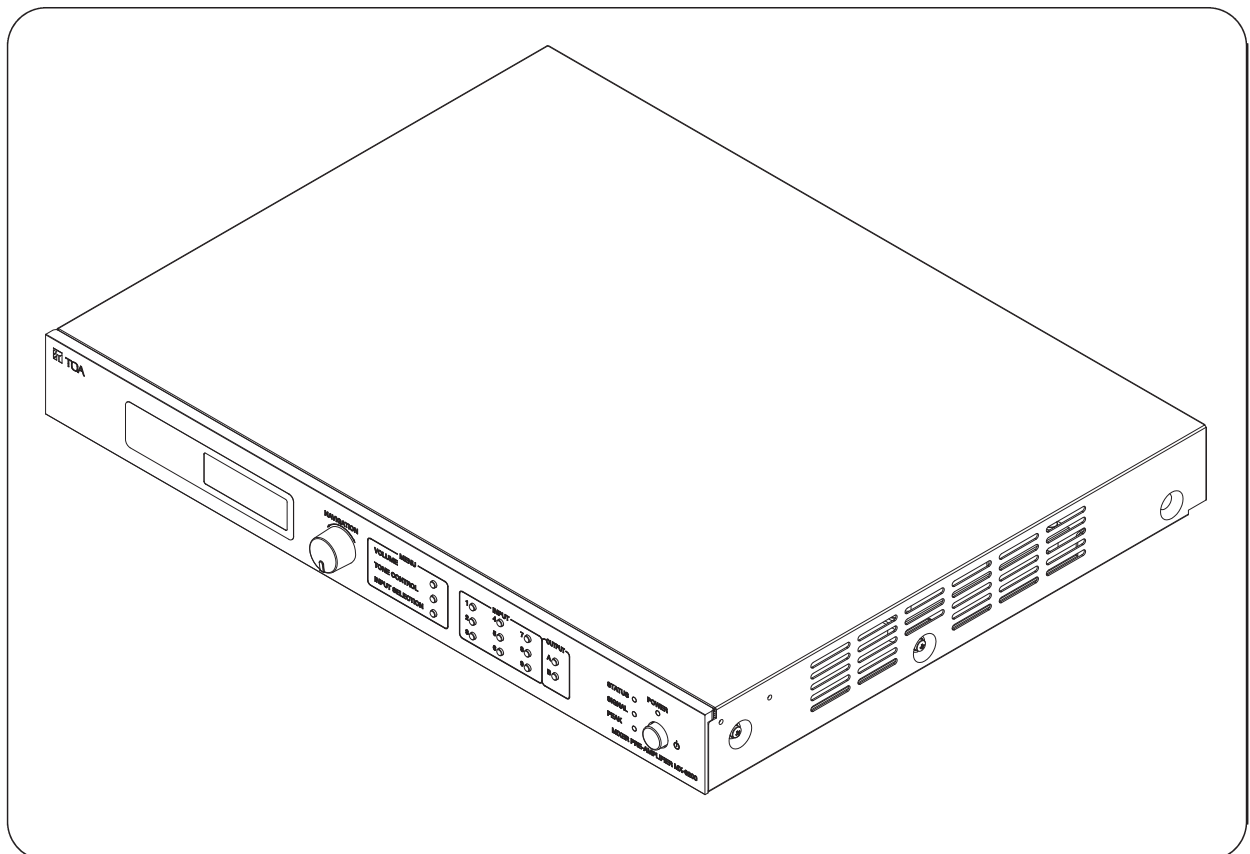

OPERATING INSTRUCTIONS

MIXER PRE-AMPLIFIER

MX-9200-AS 1



Please follow the instructions in this manual to obtain the optimum results from this unit.
We also recommend that you keep this manual handy for future reference.

TOA Corporation

TABLE OF CONTENTS

1. SAFETY PRECAUTIONS	3
2. GENERAL DESCRIPTION	4
3. FEATURES	4
4. NOMENCLATURE AND FUNCTIONS	5
5. RACK MOUNTING	7
6. CONNECTION	8
6.1. Example of External Equipment Connections	8
6.2. MX-9200-AS Connection with A-2000/A-3200D Series	8
6.3. MX-9200-AS Connection with P-2240/P-3248D	9
6.4. MX-9200-AS 2 Zones Connection with FV-224PA and FV-248PA	9
7. SOFTWARE INSTALLATION	10
7.1 Android Smartphone/Tablet Software Installation	10
7.2 PC Setting Software Installation	11
8. HOW TO OPERATE	12
8.1. Operation with Android Application	12
8.1.1. Switch Mode Configuration	12
8.1.2. Paired Device	12
8.1.3. Login to Main Menu	12
8.1.4. Manage Device	13
8.1.5. Add, Rename and Delete Item Settings	14
8.1.6. Connect and View Item Settings.....	15
8.1.7. Set Volume and Muting Channel	15
8.1.8. Set Volume and Muting Output	15
8.1.9. Tone Control and Input Selection	16
8.1.10. Others Settings	17
8.1.11. Factory Preset	18
8.2. Manual Operation	19
8.3. Remote Operation by PC	20
9. UPDATE FIRMWARE	23
10. DIMENSIONAL DIAGRAM	25
11. SPESIFICATION	26

1. SAFETY PRECAUTIONS

- Be sure to read the instructions in this section carefully before use.
- Make sure to observe the instructions in this manual as the conventions of safety symbols and messages regarded as very important precautions are included.
- We also recommend you keep this instruction manual handy for future reference.

Safety Symbol and Message Conventions

Safety symbols and messages described below are used in this manual to prevent bodily injury and property damage which could result from mishandling.

Before operating your product, read this manual first and understand the safety symbols and messages so you are thoroughly aware of the potential safety hazards.



WARNING

Indicates a potentially hazardous situation which, if mishandled, could result in death or serious personal injury.



CAUTION

Indicates a potentially hazardous situation which, if mishandled, could result in moderate or minor personal injury, and/or property damage.



WARNING

When Installing the Unit

- Do not expose the unit to rain or an environment where it may be splashed by water or other liquids, as doing so may result in fire or electric shock.
- Use the unit only with the voltage specified on the unit. Using a voltage higher than that which is specified may result in fire or electric shock.
- Do not cut, kink, otherwise damage nor modify the power supply cord. In addition, avoid using the power cord in close proximity to heaters, and never place heavy objects -- including the unit itself -- on the power cord, as doing so may result in fire or electric shock.
- The socket - outlet shall be installed near the equipment and the plug (disconnecting device) shall be easily accessible.
- Be sure to ground to the safety ground (earth) terminal to avoid electric shock. Never ground to a gas pipe as a catastrophic disaster may result.

When the Unit is in Use

- Should the following irregularity be found during use, immediately switch off the power, disconnect the power supply plug from the AC outlet and contact your nearest TOA dealer. Make no further attempt to operate the unit in this condition as this may cause fire or electric shock.

- If you detect smoke or a strange smell coming from the unit.
- If water or any metallic object gets into the unit.
- If the unit falls, or the unit case breaks.
- If the power supply cord is damaged (exposure of the core, disconnection, etc).
- If it is malfunctioning (no tone sounds).
- To prevent a fire or electric shock, never open nor remove the unit case as there are high voltage components inside the unit. Refer all servicing to you nearest TOA dealer.
- Do not place cups, or other containers of liquid or metallic objects on top of the unit. If they accidentally spill into the unit, this may cause a fire or electric shock.
- Do not insert nor drop metallic object or flammable materials in the ventilation slots of the unit's cover as this may result in fire or electric shock.



CAUTION

When Installing the Unit

- Never plug in nor remove the power supply plug with wet hands, as doing so may cause electric shock.
- When unplugging the power supply cord, be sure to grasp the power supply plug: never pull on the cord itself. Operating the unit with a damaged power supply cord may cause a fire or electric shock.

- When moving the unit, be sure to remove its power supply cord from the wall outlet. Moving the unit with the power cord connected to the outlet may cause damage to the power cord, resulting in fire or electric shock. When removing the power cord, be sure to hold its plug to pull.
- Do not block the upper panel ventilation slots in the unit's cover. Doing so may cause heat to build up inside the unit and result in fire.
- Avoid installing the unit in humid or dusty locations, in locations exposed to the direct sunlight, near the heaters, or in locations generating sooty smoke or steam as doing otherwise may result in fire or electric shock.

When the Unit is in Use

- Do not place heavy objects on the unit as this may cause it to fall or break which may result in personal injury and/or property damage. In addition, the object itself may fall off and cause injury and/or damage.

2. GENERAL DESCRIPTION

TOA's Mixer pre-amplifier MX-9200-AS is a wireless mixer having 9 input channels including 4 channels input MIC with phantom, 1 selectable input with options MIC or AUX, 3 selectable input with options MIC or LINE and 1 selectable input with options MIC or streaming from smartphone. Has remote function by smartphone for settings purposes. Parameter settings are Volume, Bass, Middle, Treble, Muting, and Input Selector.

3. FEATURES

- Remote controlling audio system by android application.
- 9 channel audio input with optional Microphone, Aux and Line.
- 1 channel input microphone with interrupt function.
- 1 channel audio streaming with smartphone via bluetooth.
- 4 channel input microphone with phantom voltage.
- 2 channel audio output with optional 0 dB, -10 dB and -20 dB audio level.
- Tone control: Bass, Middle, Treble with boost and cut ± 13 dB.
- Muting control for each channel input and output.

4. NOMENCLATURE AND FUNCTIONS

[FRONT]

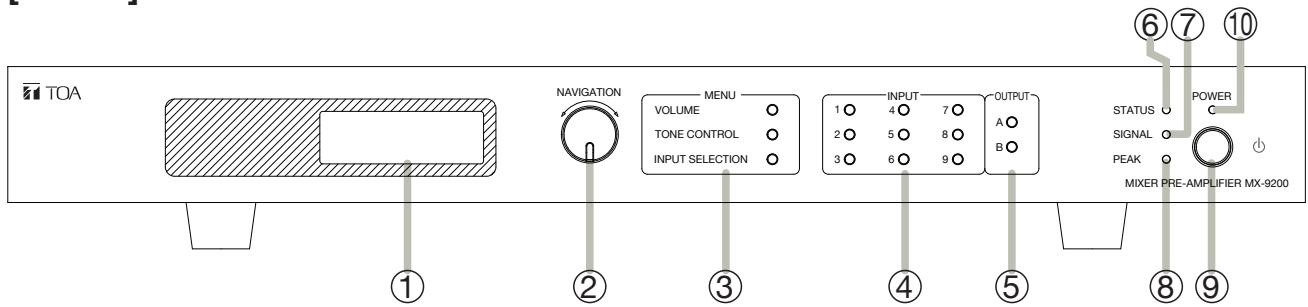

1. LCD Display

LCD 16x2 Character. Use for menu configuration display, manual key operation display, etc.

2. NAVIGATION Control

Rotary switch for settings purposes. User can setting parameter in the panel, will show menu in LCD and use Navigation switch as selector. Navigation switch can rotate to the left and right, also can push for entering the option.

3. MENU Setting

- VOLUME Switch
Shortcut switch for entering volume control menu. Users can adjust volume of each channel input and output with range 0 dB maximum to mute.
- TONE CONTROL Switch
Shortcut switch for entering tone control menu. Users can set the tone control for each channel input (Bass, middle and treble), with boost and cut value ± 13 dB.
- INPUT SELECTION Switch
Users can choose input sources according to user needs. Below are options that can be used for :
 - Channel 1 - 4 : Microphone
 - Channel 5 : Microphone, Aux
 - Channel 6 - 8 : Microphone, Line
 - Channel 9 : Microphone, Streaming by phone

4. INPUT Switch

Tactile switch channel input 1 - 9. Switch to select which input channel user want to set.

5. OUTPUT Switch

Tactile switch channel output A - B. Switch to select which output channel user want to set.

6. STATUS Indicator

Lights green for indicates that panel while connected with user's smartphone.

7. SIGNAL Indicator

Lights green for indicates present of an output signal.

8. PEAK Indicator

Lights red to indicate the output signal reaches the peak level, this indicates that sound is distorted. In such case, adjust each volume control to reduce output level.

9. POWER Switch

Push switch to turn ON the DC supply.

10. POWER Indicator

Lights green when power is ON.

[REAR]

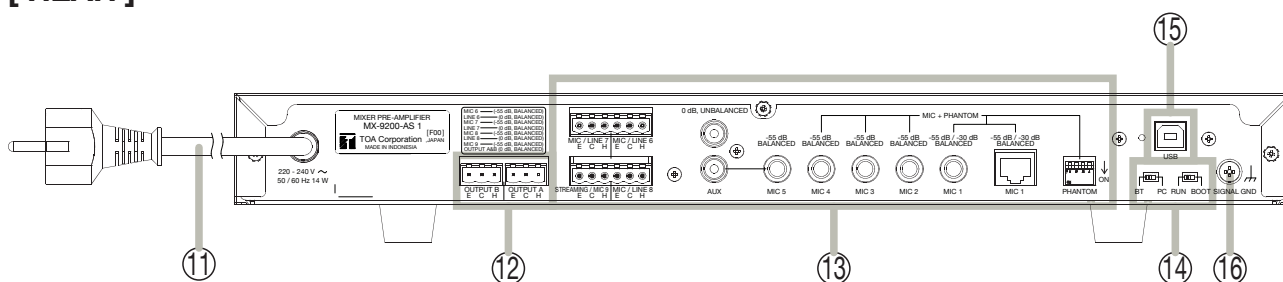

11. AC Power Cord

Connect to an AC power source, 220 - 240 V AC.

12. Audio Output (CH A & B)

Signal output to amplifier with audio level 0 dB flat, rated 1 kHz, balanced, removable terminal 3 pins. User can set audio level of signal output with optional 0 dB, -10 dB and -20 dB.

13. Audio Input (CH 1 - 9)

There are 9 input channels, below are options that can be used by user:

- Channel 1 : Microphone with optional connector are phone jack and RJ45 connector. (for EC-380 Chime microphone), sensitivity -55 dB / -30 dB, 2.2 k Ω , rated 1 kHz, balanced. Supported phantom source 19 V DC.
- Channel 2 - 4 : Microphone, sensitivity -55 dB, 2.2 k Ω , rated 1 kHz, balanced, phone jack. Supported phantom source 19 V DC.
- Channel 5 : have 2 selection input:
Microphone, sensitivity -55 dB, 2.2 k Ω , rated 1 kHz, balanced, phone jack.
Auxiliary, sensitivity 0 dB, 10 k Ω , rated 1 khz, unbalanced monoaural, RCA jack.
- Channel 6 - 8 : have 2 optional level input:
Microphone, sensitivity -55 dB, 2.2 k Ω , rated 1 kHz, balanced, removable terminal 3 pins.
Line, sensitivity 0 dB, 2.2 k Ω , rated 1 kHz, balanced, removable terminal 3 pins.
- Channel 9 : have 2 selection input:
Microphone, sensitivity -55 dB, 2.2 k Ω , rated 1 kHz, balanced, removable terminal 3 pins.
Streaming by phone, sensitivity 0 dB, 10 k Ω , rated 1 khz, unbalanced.

PHANTOM switch, there is a dip-switch to activate the phantom voltage function on channel 1 - 4.

14. Mode Switch

MX-9200-AS can be operated by the user in 3 modes. Manual from front panel switch, control by smartphone and control by PC.

- When user wants to control with a smartphone, then slide the BT-PC switch to BT. For detail instruction please see to REMOTE OPERATION BY APPS section.
- When user wants to control with PC, then slide the BT-PC switch to PC. for detail instruction please see to REMOTE OPERATION BY PC section.

And make sure the RUN-BOOT switch to RUN for both of modes.

Users can also update the firmware in the panel by themselves. Slide BT-PC switch to PC and RUN-BOOT switch to BOOT. For detail instruction please see to UPDATE FIRMWARE section.

15. USB Connector

A connector for connecting to PC via USB. PC can do audio settings and firmware update regarding to MODE switch.

16. Ground Terminal

Connect to ground (earth) to avoid electric shock.

5. RACK MOUNTING

To mount the unit in a standard 19" equipment rack, the rack mounting bracket MB-15B (optional) is required. Follow the procedures below.

Step 1. Remove the rubber foot from the bottom of the unit.

Step 2. Attach the rack mounting bracket MB-15B to the unit.

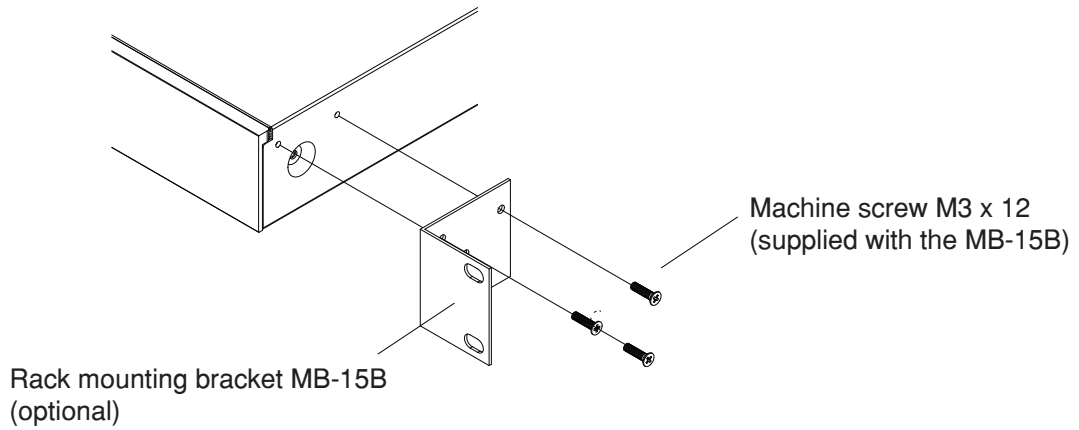

Step 3. Fix the unit in the rack.

Use the rack mounting screws that are appropriate for the rack.

Note:

The rack-mounting screws supplied with the MB-15B can be used for the TOA equipment rack only. Illustrated below is a unit mounting method to the TOA rack.

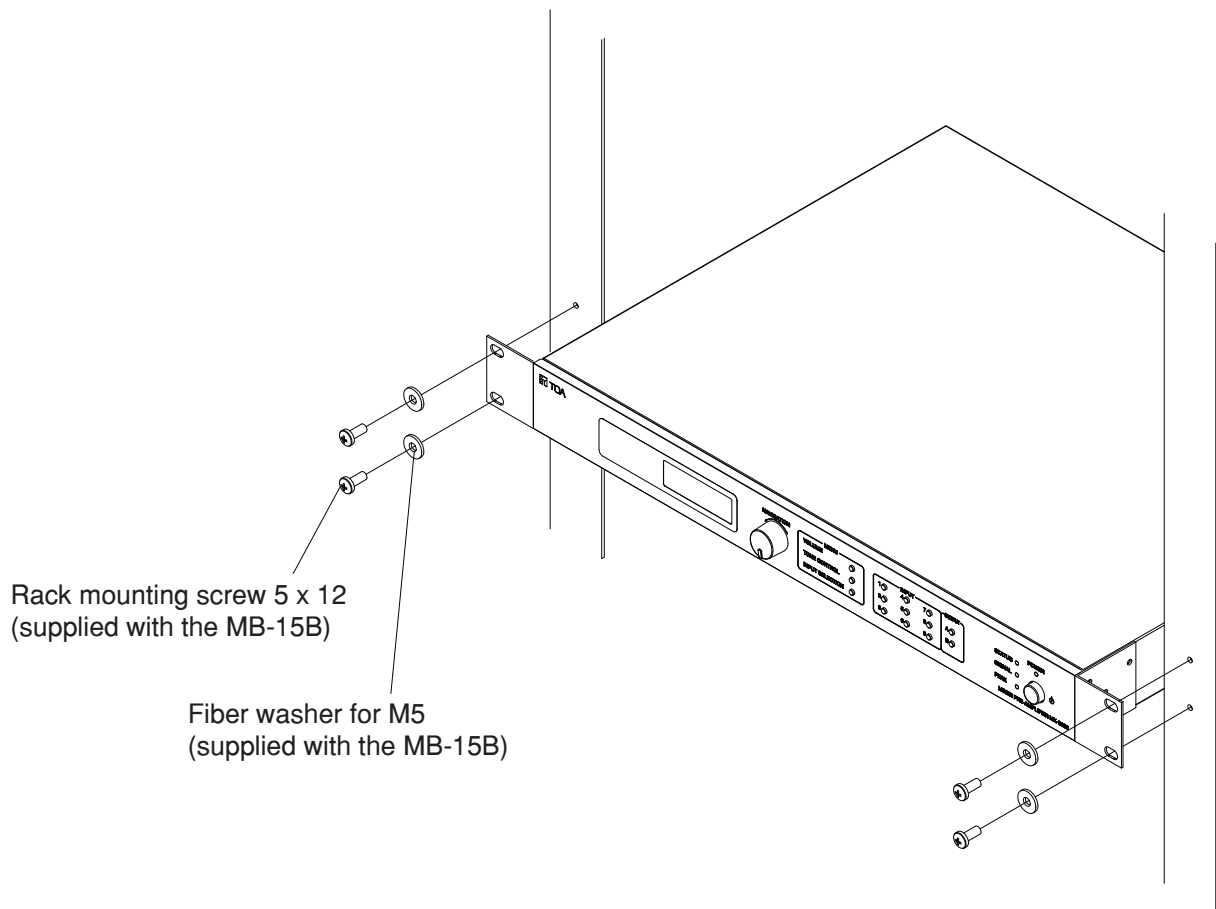

6. CONNECTION

Mixer Pre-Amplifier has 9 input channels that can be used by users. Also has a variety of modes on the input and output that can be selected according to user needs. On the input, some channels have an option for the user to choose which input sensitivity is selected as needed, such as sensitivity Microphone -55 dB, Auxiliary 0 dB, Line 0 dB and Chime Microphone EC-380 -30 dB. Then in output, user can also make adjustments to the output level, the choices include 0 dB, -10 dB and -20 dB. The following is a connection diagram for audio source input that can be connected with a MX-9200-AS pre-amplifier mixer.

6.1 Example of External Equipment Connections

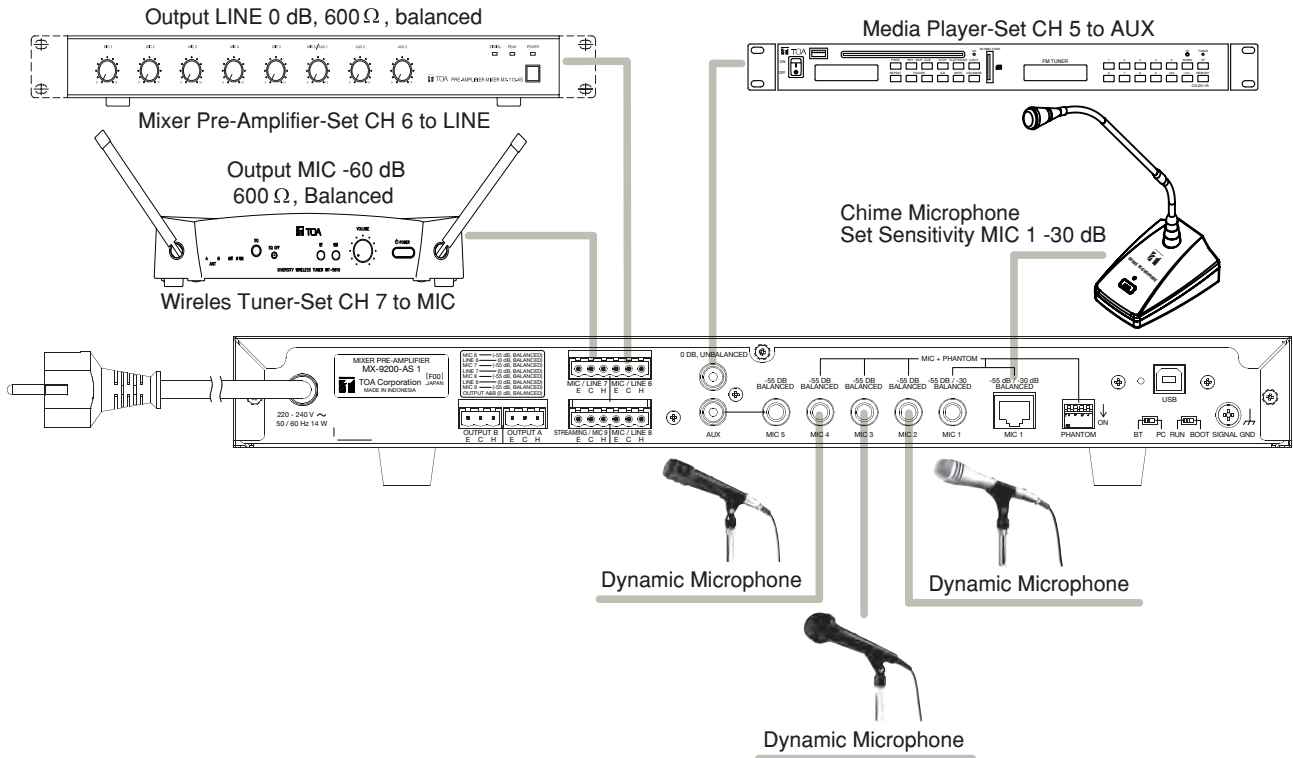

Ensure that the input sensitivity of each channel in MX-9200-AS Mixer Pre-amplifier is adjusted according to the output sensitivity of the audio source. For detailed instructions how to adjust sensitivity on the input channel, can be seen in the **How to Operate** section.

In the output section can also be adjusted according to what power amplifier is used.

6.2 MX-9200-AS Connection with A-2000/A-3200D Series

For Example, MX-9200-AS connection with A-2240D like below.

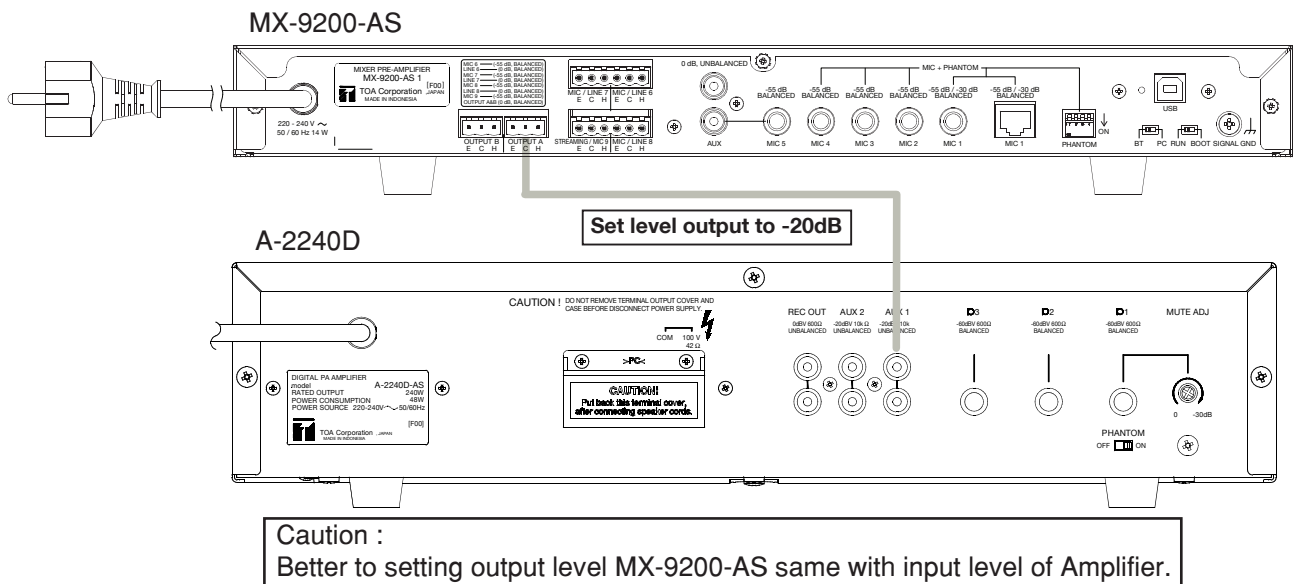

6.3 MX-9200-AS Connection with P-2240/P-3248D

For Example, MX-9200-AS connection with P-2240 like below.

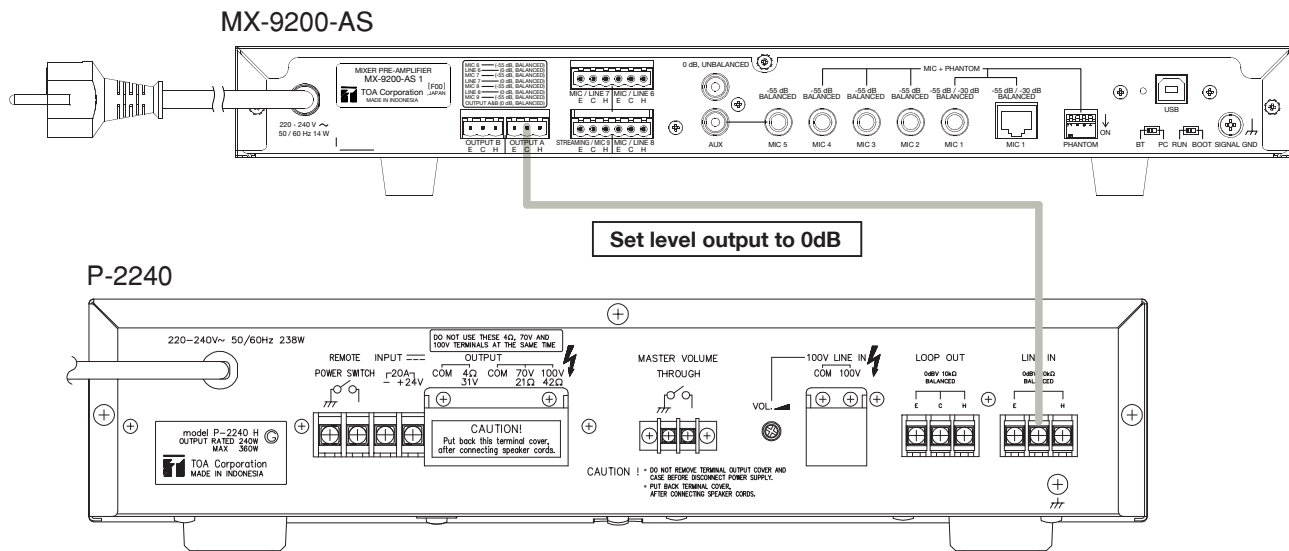

6.4 MX-9200-AS 2 Zones Connection with FV-224PA and FV-248PA

For Example, MX-9200-AS 2 zones connection with FV-224PA and FV-248PA like below.

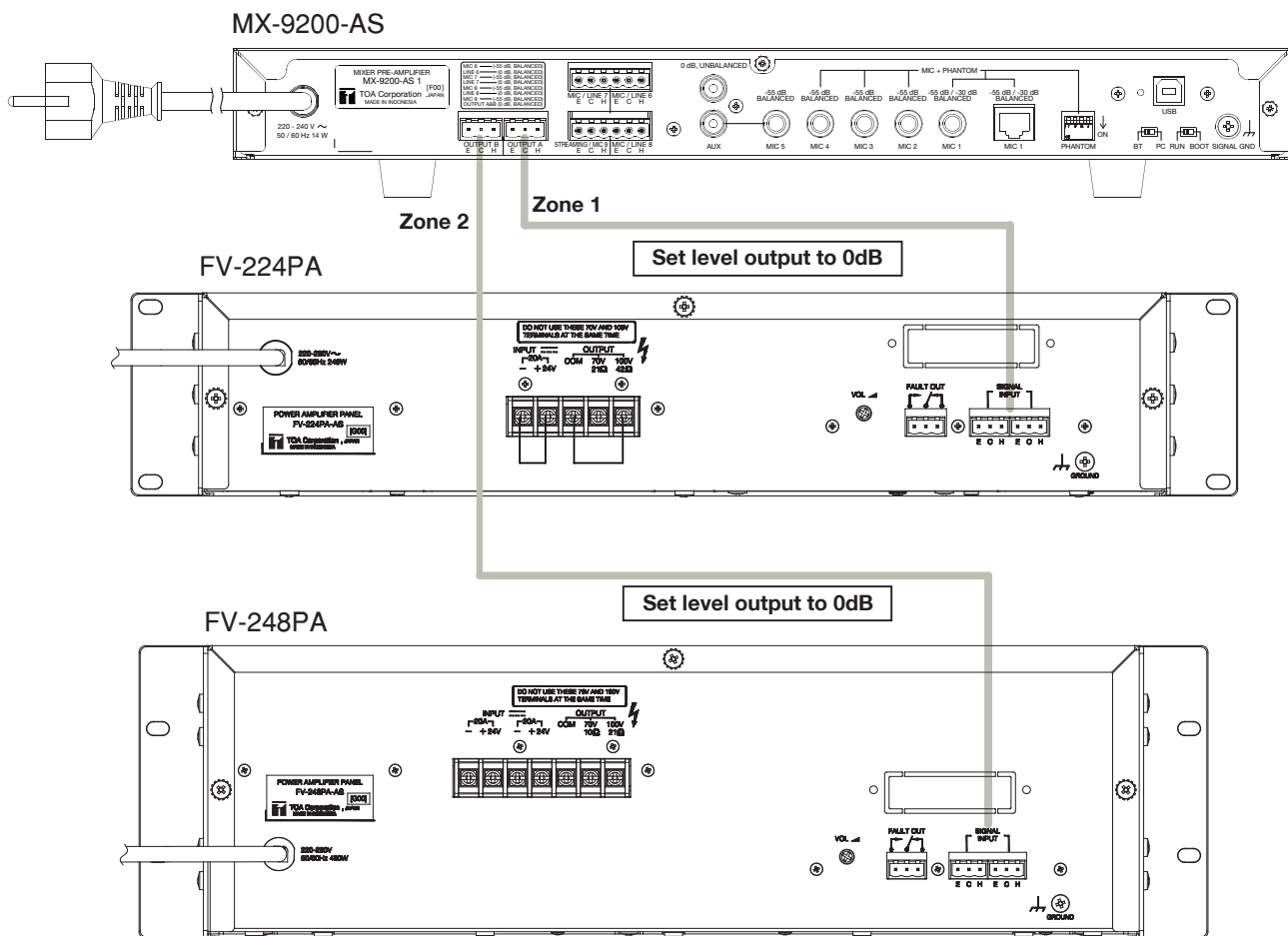

For detailed instructions on how to adjust sensitivity on the output channel, can be seen in the **How to Operate** section.

7. SOFTWARE INSTALLATION

7.1 Android Smartphone/Tablet Software Installation

User have to download MX-9200-AS application apk file at TOA website (URL <https://toa.com.sg/product/MX-9200-Pre-Amplifier-Mixer>).
Apk files are also available on the accessories CD.

Installation Instruction

1. Open Apk file with your favorite file manager



2. If this warning show, select Settings or go to your phone setting → security → Inst all unknown apps (This may different on every android phone) if not skip to step 4

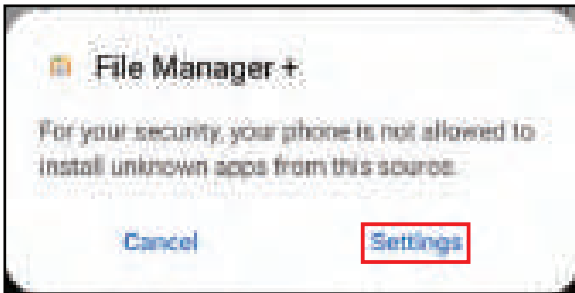

3. Turn on unknown sources for your file manager to allow installation apk using your file manager

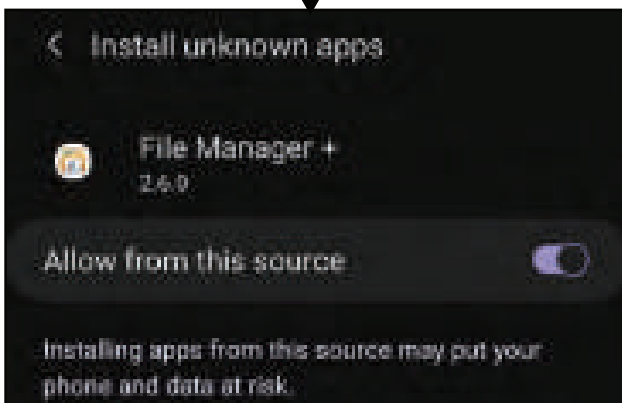
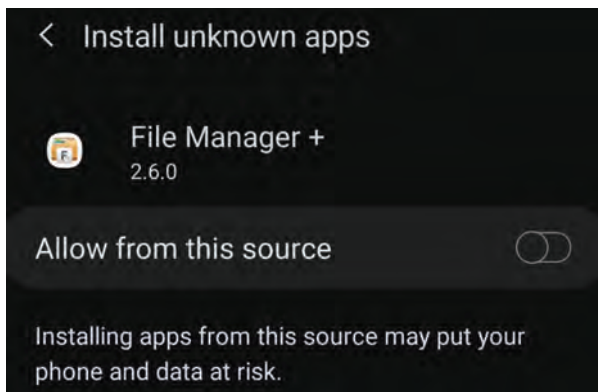

4. Select Install

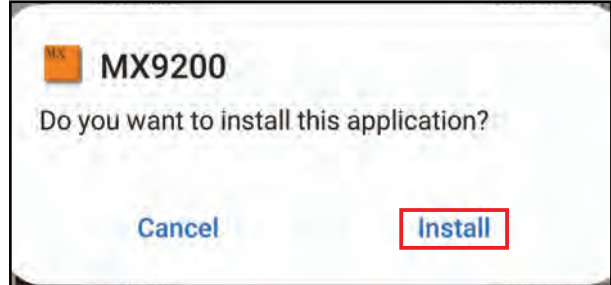

5. Wait for installation process and select open to start MX-9200-AS application

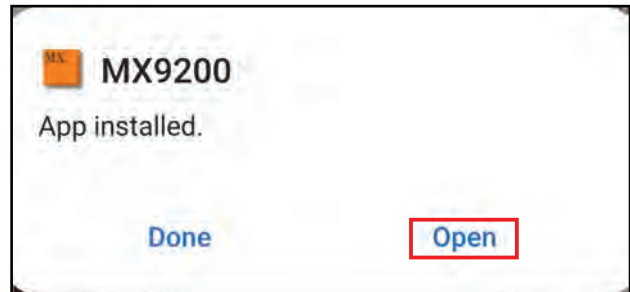

7.2 PC Setting Software Installation

User have to install application from CD installer or website download with PC/laptop specification are :

- Windows XP SP3, Windows 7/8 or higher.
- RAM 1 GB.
- Minimum Processor Intel Pentium 4.

Installation Instruction

1. Open setup file

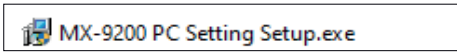

2. Click **Next**.

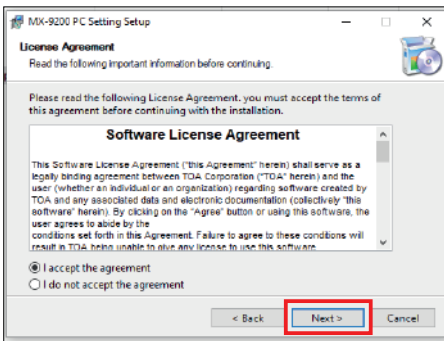
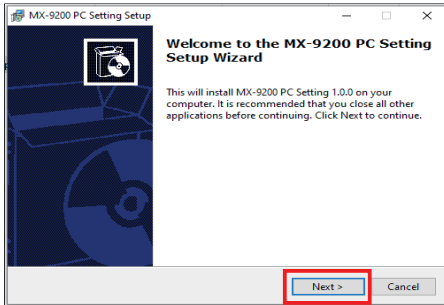

Choose "I accept the agreement" then click **Next**

3. Choose your destination folder and click **Next**

Default destination on windows 64 bit is

- C:\Program Files (x86)\TOA\MX-9200 PC Setting\
- Default destination on windows 32 bit is
- C:\Program Files\TOA\MX-9200 PC Setting\

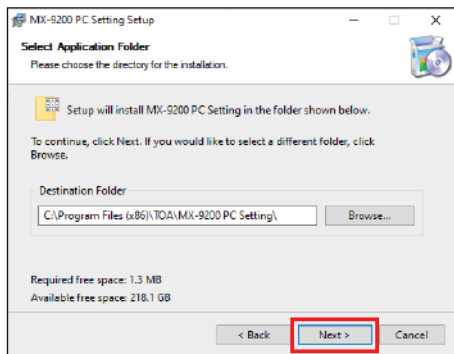

4. Check Create desktop icon tick-box to create shortcut at desktop and click **Next**

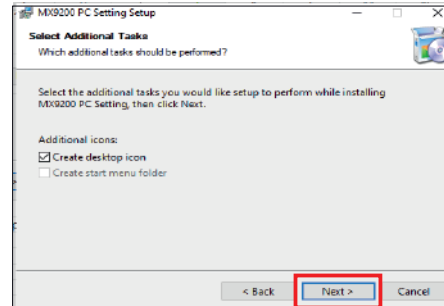

5. Wait for installation finish and click **Finish**.

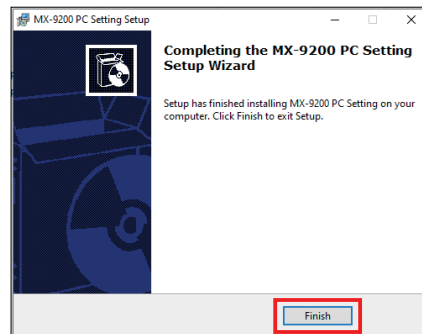

6. MX-9200-AS PC Setting program should be on your desktop and on folder destination that you choose before

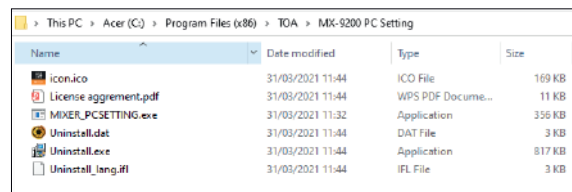
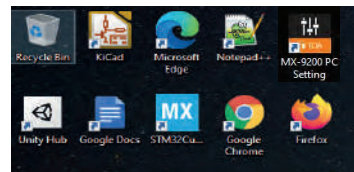

8. HOW TO OPERATE

Mixer Pre-Amplifier has 3 options operation, remote operation with android application in user's smartphone, remote operation by PC, and manual operation with LCD menu on front panel. In this section, will explain how to operate this device in each operation.

8.1 Operation with Android Application

8.1.1 Switch Mode Configuration

Ensure that the switch mode setting on the back panel matches the image below.

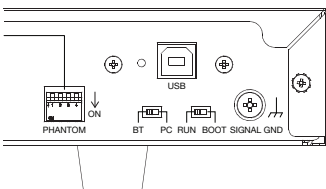

Turn Off power switch of MX-9200-AS, set BT-PC switch to BT and RUN-BOOT switch to RUN, then turn back on power switch.

8.1.2 Paired Device

Before searching the device, make sure the STATUS light on the front panel is Off. If the STATUS light is On, it means that the MX-9200-AS is connected to another smartphone. When the MX-9200-AS is connected to one smartphone, the MX-9200-AS cannot be found on another smartphone when searching for devices. Then go to Bluetooth Configuration on smartphone settings, then do a search. Then the device name MX-9200-AS will appear on the list of founded devices with the default name TOA_MIXER, then do a pairing and it will look like in the image below.

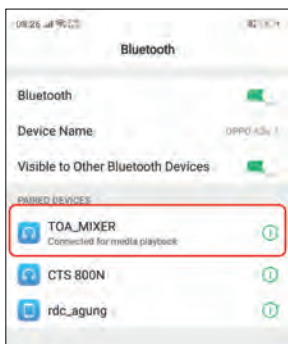

After successfully pairing the device, user's smartphone is connected to the MX-9200-AS and is ready to use the MX-9200-AS android application.

8.1.3 Login to Main Menu

Open the MX-9200-AS application on the user's smartphone, then a menu will appear as shown below.

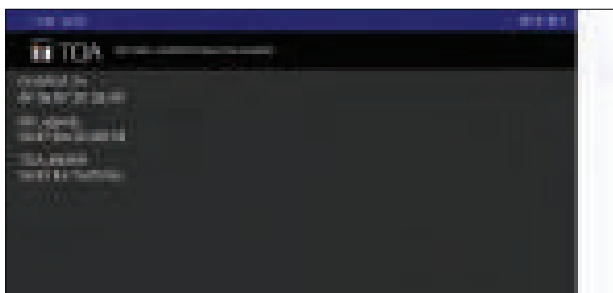

If the user's smartphone has ever paired with MX-9200-AS the device name MX-9200-AS will appear in the list with the default name TOA_MIXER. Then select the TOA_MIXER item and the user will go to the LOGIN menu.

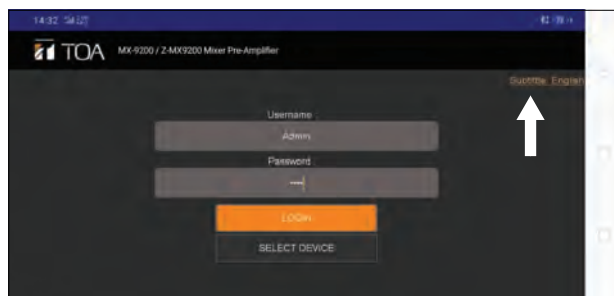

Entry username and password and click "LOGIN" button.
Username: admin (default)
Password: 1234 (default)

User can also edit the subtitles by clicking on the text subtitle in the upper right corner, then the menu options will appear as shown.

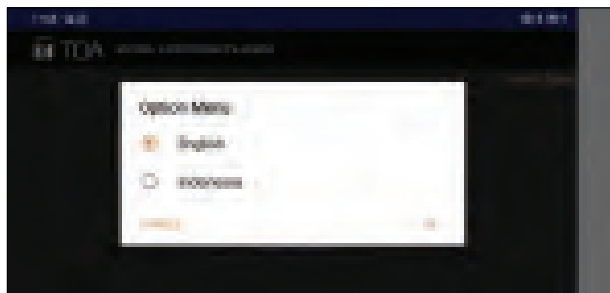

Select the language user want to use and select OK

The username and password can be changed in the Manage Device menu (refer to Manage Device sub-section). Username and password value will send by apps to MX-9200-AS panel and will do comparison with saved value in MX-9200-AS panel. If login succeeds, user will go to main menu like images below.

Tablet version.



Phone version.

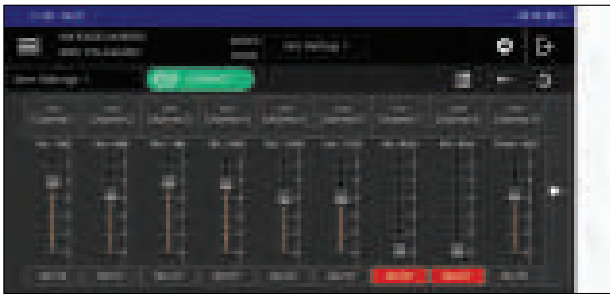

Enter a new username and press OK.

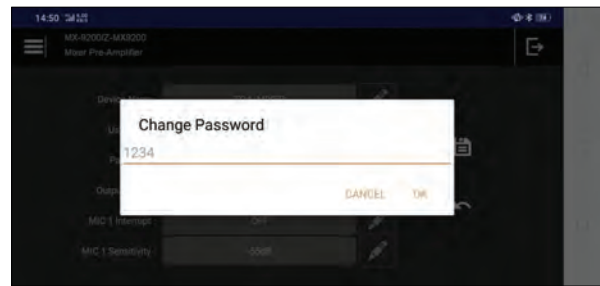

8.1.4. Manage Device

User can change the settings contained in the MX-9200-AS panel. Click the configuration icon then select Set Device.

Enter a new password and press OK. Then press the save icon to execute the command to the MX-9200-AS panel.

Note: When the user changes the device name, then user must restart the Bluetooth connection. As long as the Bluetooth connection is not restarted, the device name detected on the user's smartphone device will remain the same as the previous device's name.

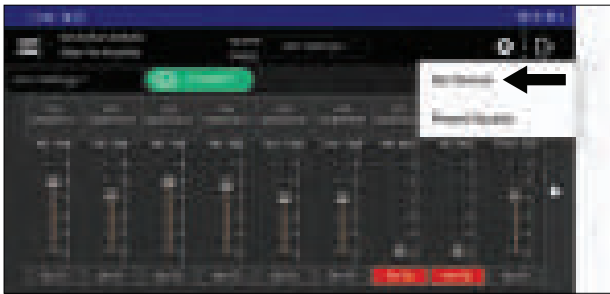

b. Output Mode Settings

In this menu, user can change settings for Device Name, Username, Password, Output Mode, MIC 1 Interrupt, and MIC 1 Sensitivity.



a. Change Device Name, Username and Password

To change the Output Mode, click on the pen icon and an edit text menu will appear as shown below. The following are the options in the Output Mode.



To change the Device Name, Username and Password, click on the pen icon and an edit text menu will appear as shown below.

This Output Mode is used to adjust the audio output level value from the MX-9200-AS panel. There are 3 choice of audio output levels are 0 dB, -10 dB and -20 dB. Users can make adjustments according to what power amplifier is used. Select and press OK, then press Save icon to execute the command to the MX-9200-AS panel.

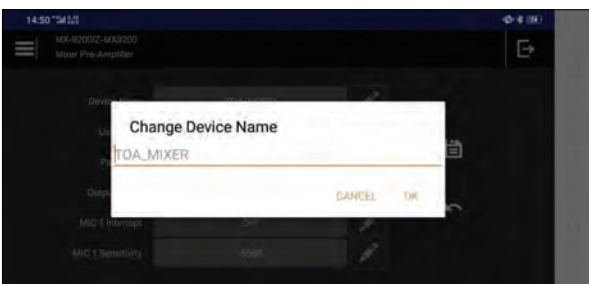

c. MIC 1 Interrupt Settings

Enter a new device name and press OK.

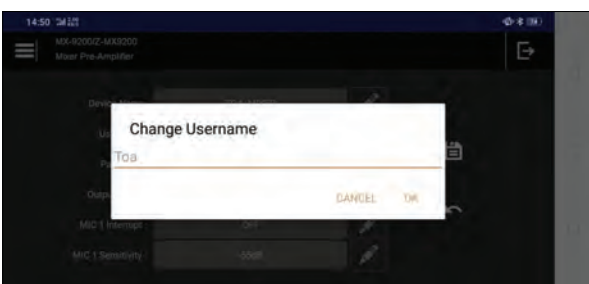
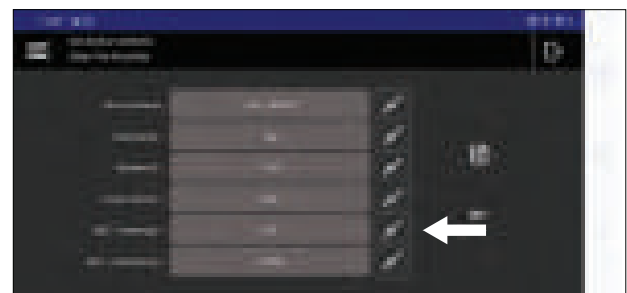

To change the MIC 1 Interrupt, click on the pen icon and an edit text menu will appear as shown below.

The following are the options in the Mic 1 Interrupt settings.

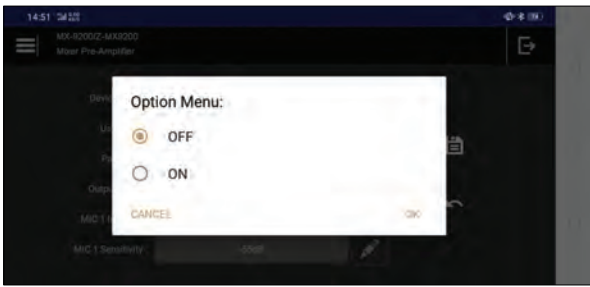

Select and press OK, then press Save icon to execute the command to the MX-9200-AS panel. This function is useful if user uses channel 1 on the RJ45 connector (used for EC-380). On the RJ45 connector there is a pin control input to give instructions to the MCU to muting other channels if the pin is active.

d. MIC 1 Sensitivity Settings



To change the MIC 1 Sensitivity, click on the pen icon and an edit text menu will appear as shown below.

The following are the options in the Mic 1 Sensitivity settings.

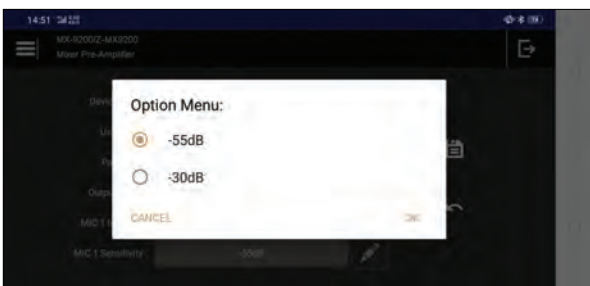

Select and press OK, then press Save icon to execute the command to the MX-9200-AS panel. Users can make input sensitivity settings on channel 1. There are 2 choices are -55 dB and -30 dB.

Note: If channel 1 is used for EC-380 or a microphone that has a high sensitivity, then it is better to use the -30 dB sensitivity setting.

8.1.5. Add, Rename and Delete Item Settings

User can view the list of item settings stored in the by clicking the menu bar icon in the upper left corner as show below.

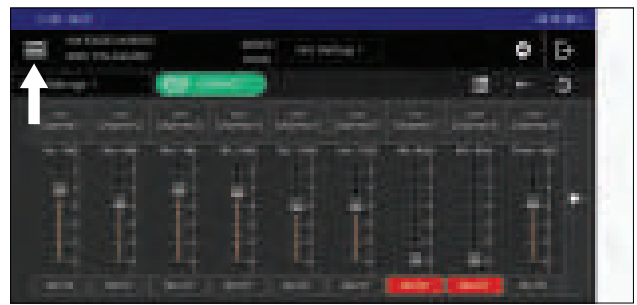

On this menu, the user can add, rename and delete the selected items settings.

a. Add Item Settings

The MX-9200-AS panel can store 50 item settings.

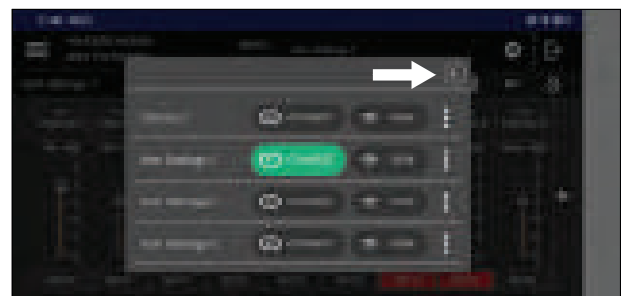

At the time of the first install there was only 1 item in the list item with default name is "DEFAULT".

Users can add items by pressing the '+' icon like image above.

Then in the item list will be added to the item with the default name "Item setting" as shown below.

If the number of items has reached 50, then adding items cannot be done.

b. Rename Item Settings

Users can rename the item name by clicking the pen icon located next to the item name. Then the input menu will appear as shown below.

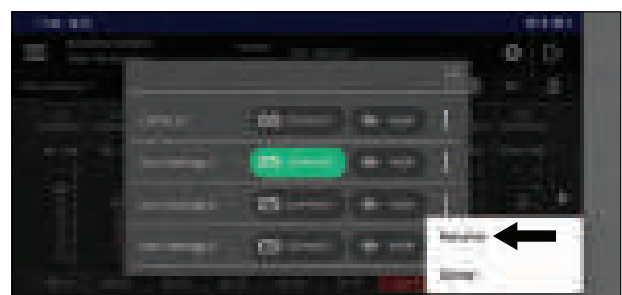

Enter a new name and press OK. Then the item name will change and the list item will refresh and appear as shown below.

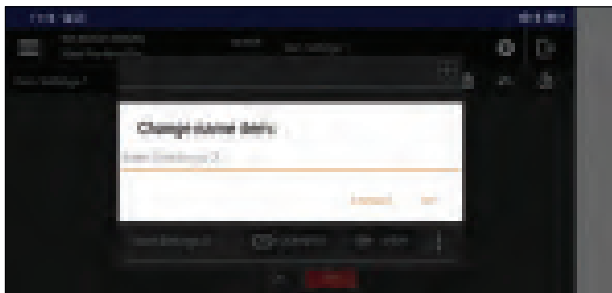

c. Delete Item Settings

Users can also delete item settings.

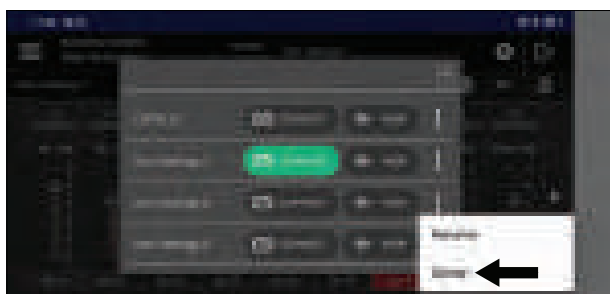

Click deleted icon like image above, then will show dialog confirmation like image below.

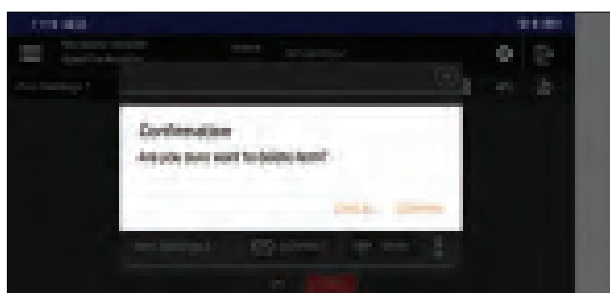

Press CONFIRM and selected item will be deleted, then items list will be refreshed.

8.1.6. Connect and View Item Settings

a. Connect Item Settings

User can do connect item settings into the MX-9200-AS panel. Select the items you want to use in the item list then press Connect button next to the name of the selected item.



Then the selected item settings will be sent to the MX-9200-AS Panel. And MX-9200-AS will activate the parameters contained in the selected item settings.

b. View Item Settings

Users can also view the parameters contained in the selected item settings. Open item list then press the view button next to the selected item name.

Then the application will load selected item and will be display on the main menu layout.

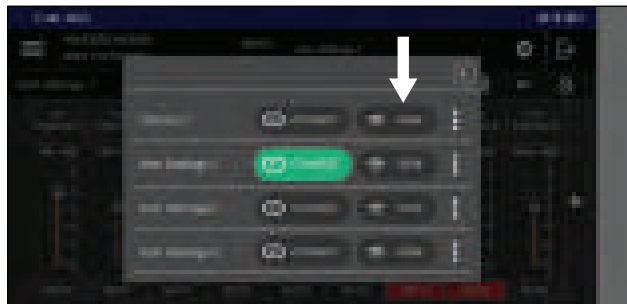

8.1.7. Set Volume and Muting Channel

In this section, user can adjust the volume of each channel through the volume bar designated by the arrow in the image below. The volume range of each channel from 0 dB to muted.

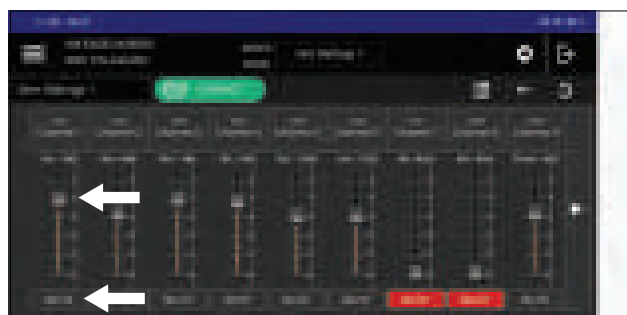

User can also muting each channel by pressing the button below the volume bar. Below the channel button written what type of audio source is used by each channel (MIC, AUX, LINE and MUTE) and volume of each channel.

8.1.8. Set Volume and Muting Output

User can also make adjustments in the output by pressing the right arrow button as pointed by the arrow in the bottom image.

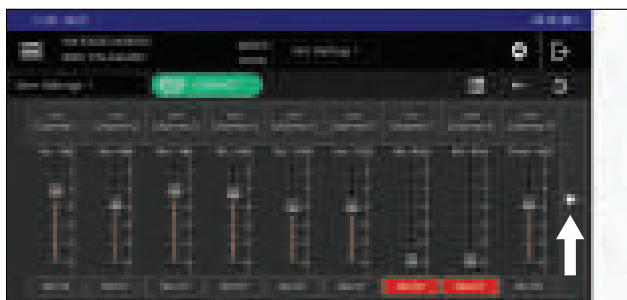

The application will open the output settings menu as shown below.



In this menu, the user can make the following settings.

a. Rename Output Label

User can change the label name by pressing the button marked with number (a). Then a dialog input will appear to enter the new label name then press OK.

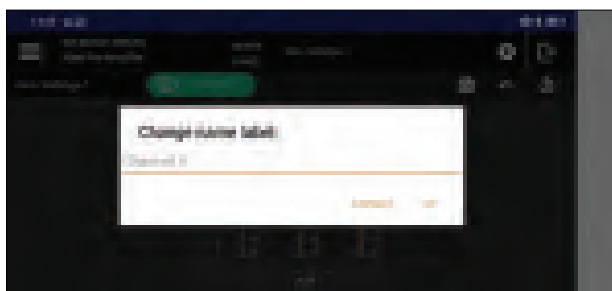

b. Set Volume

There are 2 outputs on the MX-9200-AS panel, and user can adjust the volume for each output by using the volume bar marked with number (b) in the picture above. range of output volumes from 0 dB to muted.

c. Switch On/Off Output

User can also turn on or turn off each output by pressing the button marked with number (c) in the image above.

8.1.9. Tone Control and Input Selection

Users can adjust the Tone of each channel by pressing the button as indicated by the arrow in the image below.

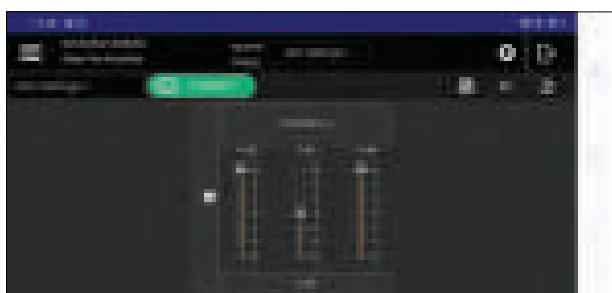

Then the user will go to the tone control menu that looks like the image below.

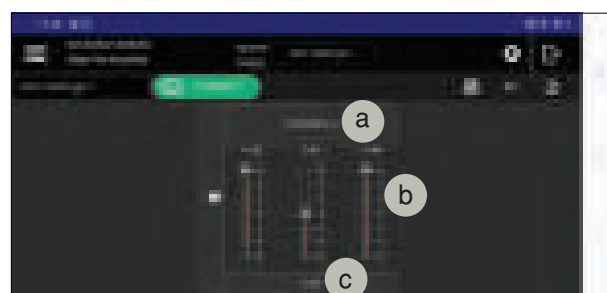

In this menu, the user can make the following settings.

a. Rename Channel Label

Users can change the label name by pressing the button marked with number (a). Then a dialog input will appear to enter the new label name then press OK.

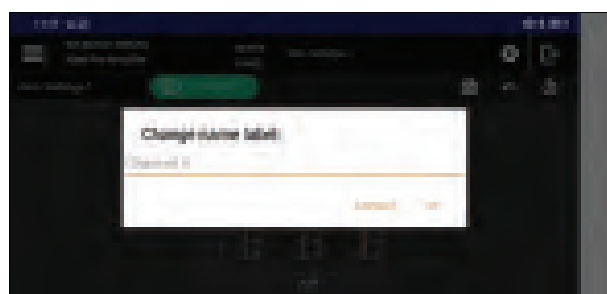

b. Set Tone

There are 3 types of tones that can be set are Bass, Middle, Treble. User can adjust the tone value by using the tone bar marked with number (b) in the picture above. The maximum boost value is +13 dB, and the maximum cut value is -13 dB.

c. Set Input Selection

Users can choose the input they want to use each Channel. Each input has different choices. On channel 1 - 4 There are only options for the microphone, then for Channel 5 there are options for microphone and Aux, Channel 6 - 8 there is a choice of microphone and Line, And for channel 9 there is a choice of microphone and Streaming by smart-phone. By pressing the button below The tone bar marked with number (c) in the image above. Then the options dialog appears as shown below.

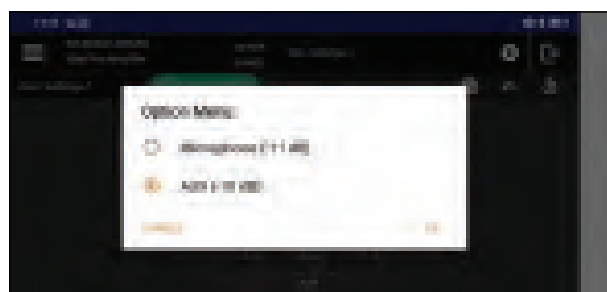

Select the input want to use, then press OK.

8.1.10. Others Settings

a. Connect Item Settings

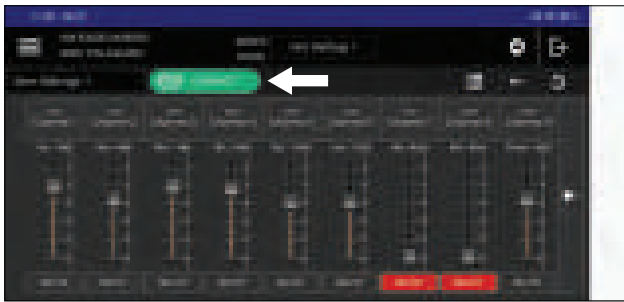

There are indicators as indicated by the arrow in the Picture above. The indicator is a marker whether the Selected item settings are connected with the MX-9200-AS Panel or not. If it is light green, it means that the Selected item settings are connected with the MX-9200-AS Panel and user can make settings directly to the MX-9200-AS panel in real time. If it does not turn on, it means that the selected item settings are not being connected with the MX-9200-AS panel, and user cannot make adjustments in the audio settings menu, only to see. Users can connect selected item settings directly with the MX-9200-AS panel by pressing the connect button.

Then a confirmation dialog will appear shown below.

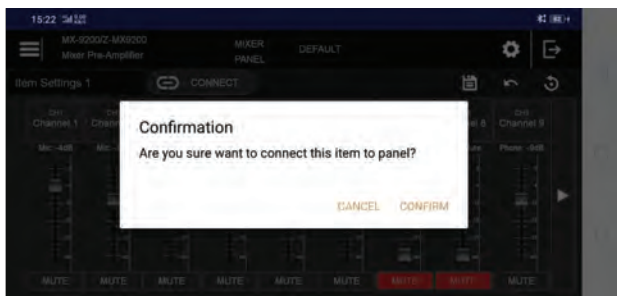

Select CONFIRM, then the application will send the Connect command to the MX-9200-AS panel. And the MCU will activate the selected item settings in the MX-9200-AS Panel. Then indicator will light green and user can make adjustments in the audio settings menu.

b. Save Item

After making changes to the settings in the audio settings menu, the user is required to save by pressing the icon as indicated by the arrow in the image below.

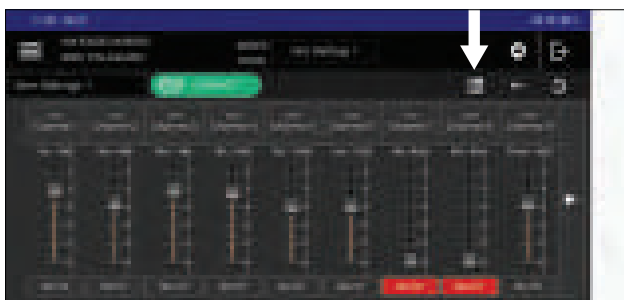

The options dialog will appear with the "Save" or "Save As" options as shown below.

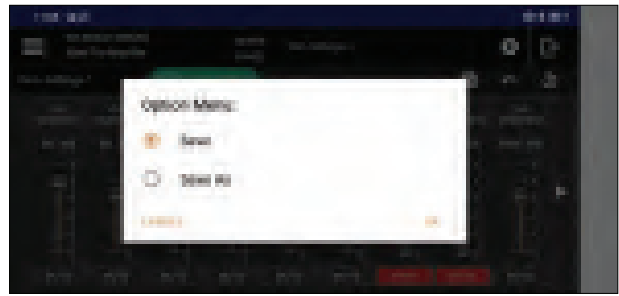

If user selects "Save", the settings change will be overwritten to the selected item settings. If the user selects "Save As" then input dialog will appear as shown below.

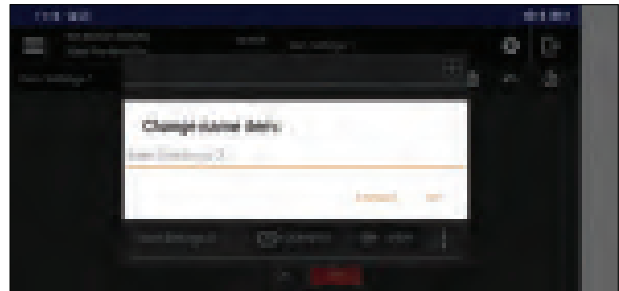

Enter the name of new item, and press OK. Then the application will ask MX-9200-AS panel to make a new item MX-9200-AS panel. and request to MX-9200-AS panel to activate it. Then the new item settings are connected with the MX-9200-AS panel.

c. Revert Item

When the user has changed the settings and wants to return to the original settings, then press the "Revert" icon as indicated by the arrow in the image below.

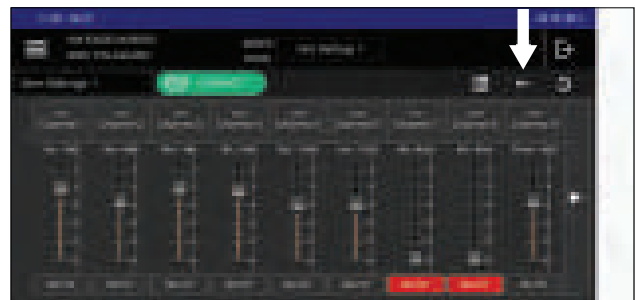

Then a confirmation dialog will appear and press CONFIRM as shown below.

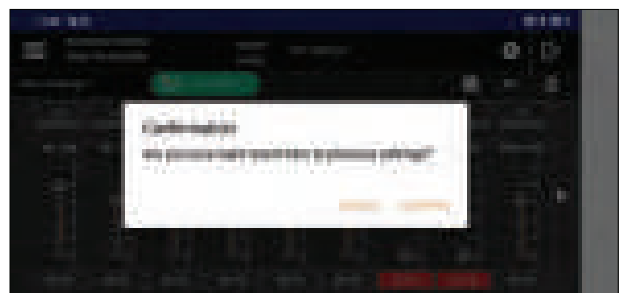

Then all setting value in selected item will return to the previous setting.

d. Reset Item

When the user wants to reset the settings of the selected item settings, then press the "Reset" icon as shown in the arrow in the image below.

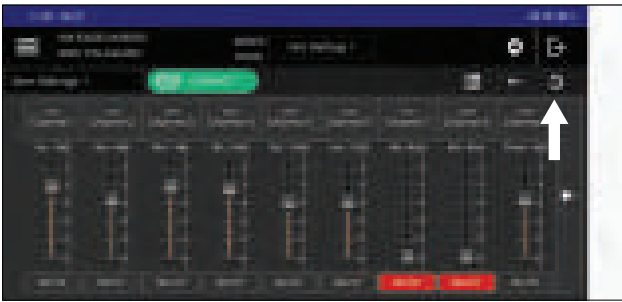

Then the user will be asked to enter a password to execute the reset command.

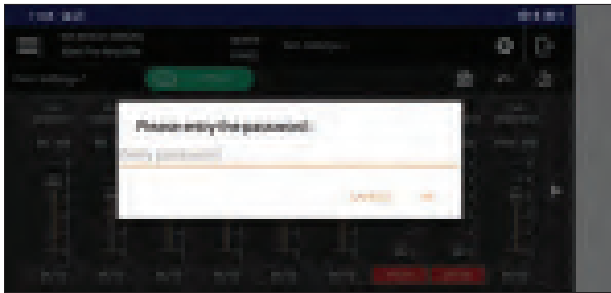

Then press OK and will show confirmation dialog like image below.

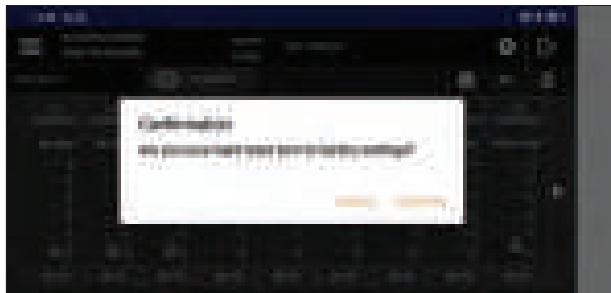

Then select CONFIRM and settings in the selected item settings will be reset to the factory settings. Unlike the Preset Factory, this reset command only resets the settings contained in the selected item settings only, and for other items will not be reset.

8.1.11. Factory Preset

Users can do factory presets by pressing the Preset Factory icon that is pointed by the arrow in the image below.

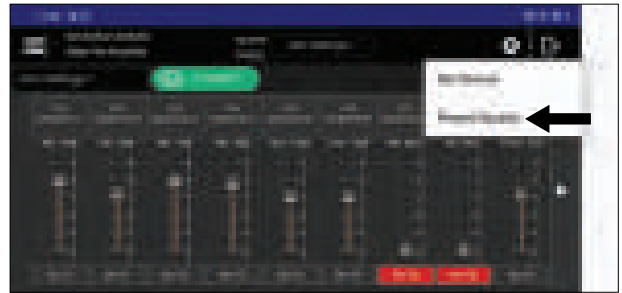

Then the user will be asked to enter a password to execute the preset command.

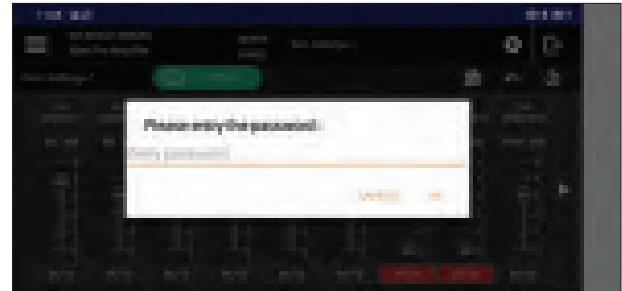

Then press OK and will show confirmation dialog like image below.

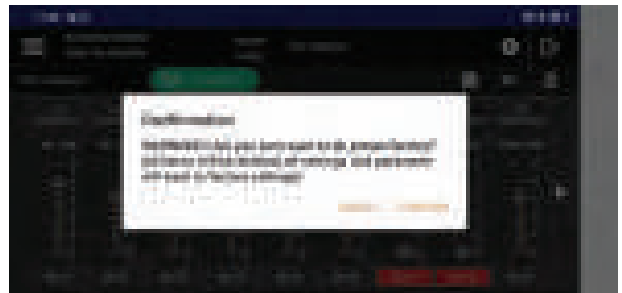

Select CONFIRM and the MX-9200-AS will preset and reset all settings back to the factory settings.

Warning:

This command will cause all saved item settings to be deleted. Also with the device name, username, password, and other device settings go back to the factory settings.

8.2 Manual Operation

First step, turn ON power Smart Mixer panel and wait until LCD show display below:

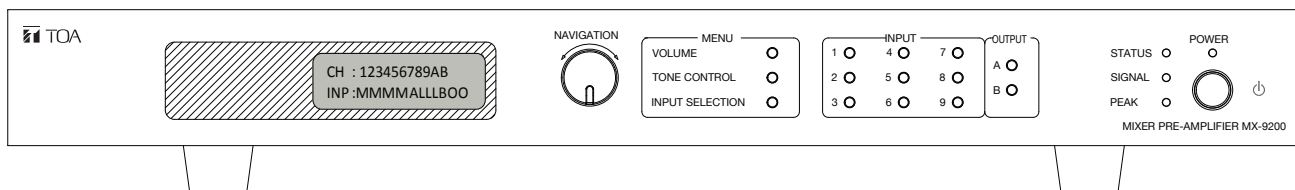

Volume Settings :

Press “VOLUME” switch①, select input or output channel switch②, then adjust volume with rotary encoder③. Volume indicator will show on LCD④.

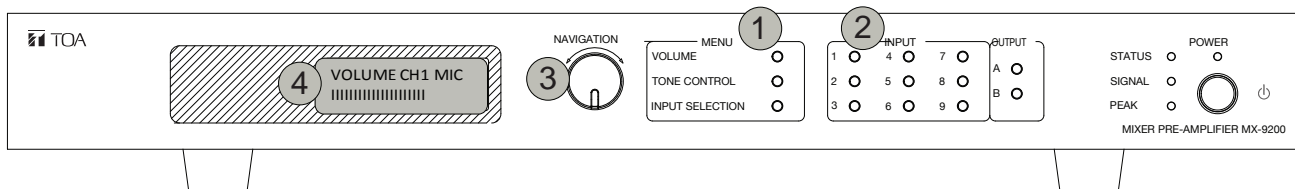

Tone Control settings :

Press “TONE CONTROL” switch①, select input channel switch②, and then select menu user want to sets③. Option menu will show on LCD④.

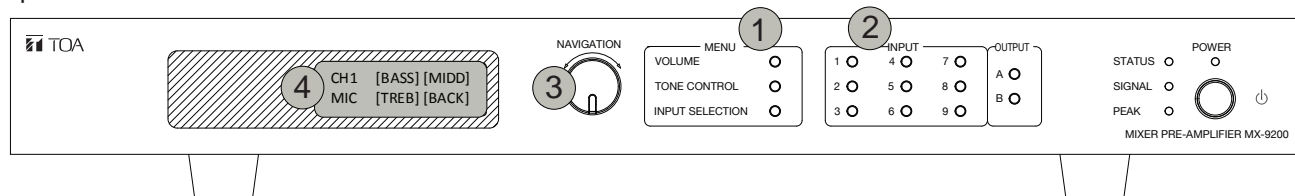

Bass, Middle, Treble:

Select “BASS” for bass band, “MIDD” for middle band, and “TREB” for treble band. Adjust value using rotary encoder.

CH1 [BASS] [MIDD]
MIC [TREB] [BACK]

Input selector settings :

Press “INPUT SELECTION” switch①, select input or output channel switch②, and then select option user want to sets③. Option menu will show on LCD④.

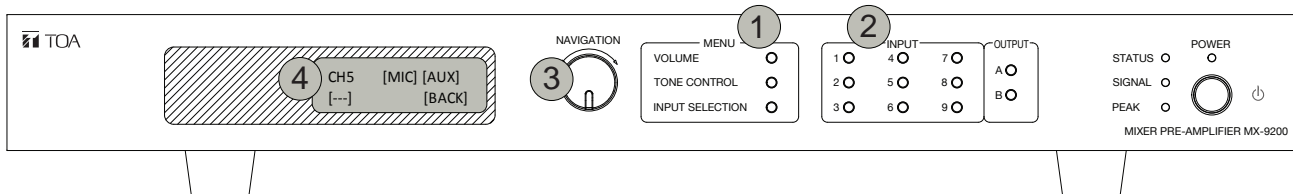

Saving parameter settings :

Press “ENTER” rotary switch and hold① until LCD show display below②.

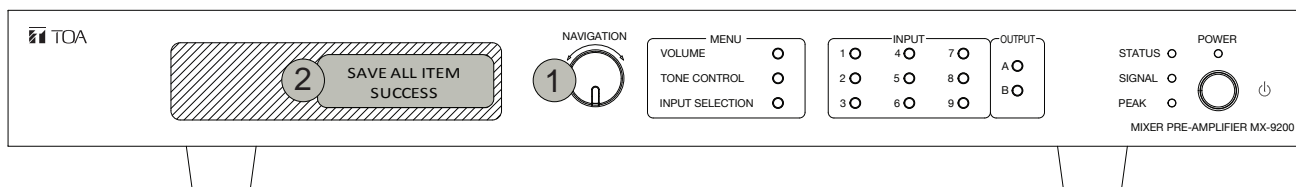

Menu configuration settings :

Press “ENTER” rotary switch ①, and then LCD show password menu ②.

Entry the password, default value: “1234”

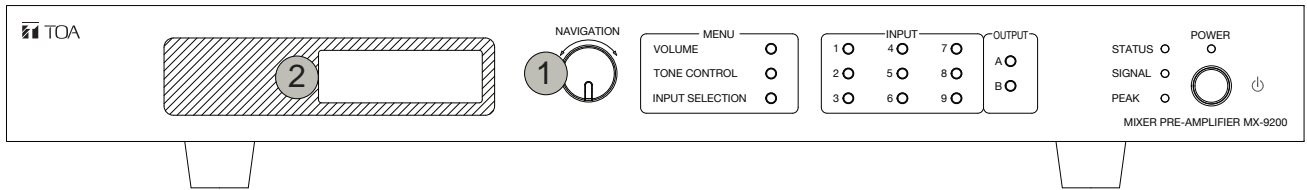

Then will go to menu configuration :

- >1. PROTECT MODE
- 2. MIC1 INTERUPT
- 3. OUTPUT MODE
- 4. MIC1SENS MODE
- 5. PARAM LIST
- 6. PRSET FACTORY
- 7. CHECK VERSION
- 8. BACK

1. PROTECT MODE : enable or disable password protection when user do setting.
2. MIC1 INTERUPT : MIC 1 will muting others channels, when control input on MIC1 is active. Control input on RJ45 connector.
3. OUTPUT MODE : set output level, have 3 options are 0 dB, -10 dB, -20 dB.
4. MIC1SENS MODE : set MIC1 sensitivity, have 2 options are -55 dB and -30 dB.
5. PARAM LIST: View parameter settings list, and selecting if user wants to load it.
6. PRSET FACTORY : Will do preset all parameter to manufacture preset value.
7. CHECK VERSION : Checking software version.
8. BACK : go to main LCD menu.

8.3 Remote Operation By PC

First, set mixer to PC mode then turn ON. Connect USB cable from PC to Mixer. Then, see if COM port already available or not at device manager.

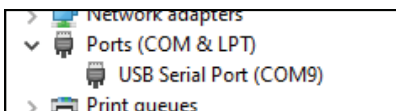

Open PC Setting application, insert user and password admin : 1234 (default) then click CONNECT button. Wait until “LOAD ALL DATA COMPLETE” message appear.

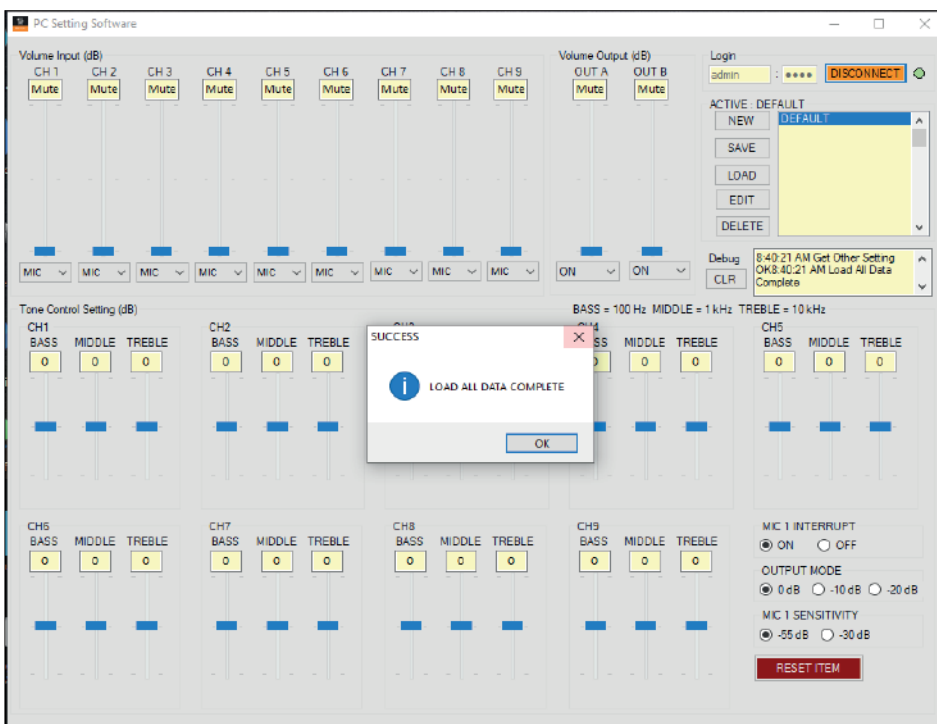
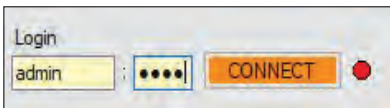

If “Please Connect to Mixer” message appear try to click connect again. If still appear make sure that usb cable connect properly, check mixer must be on PC mode and also check available com port at device manager. Restart mixer if needed.

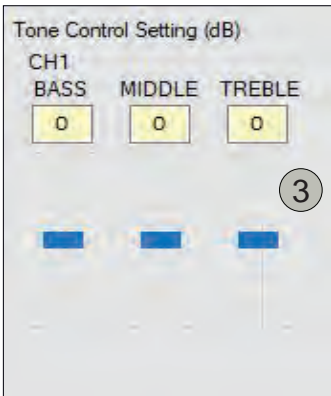
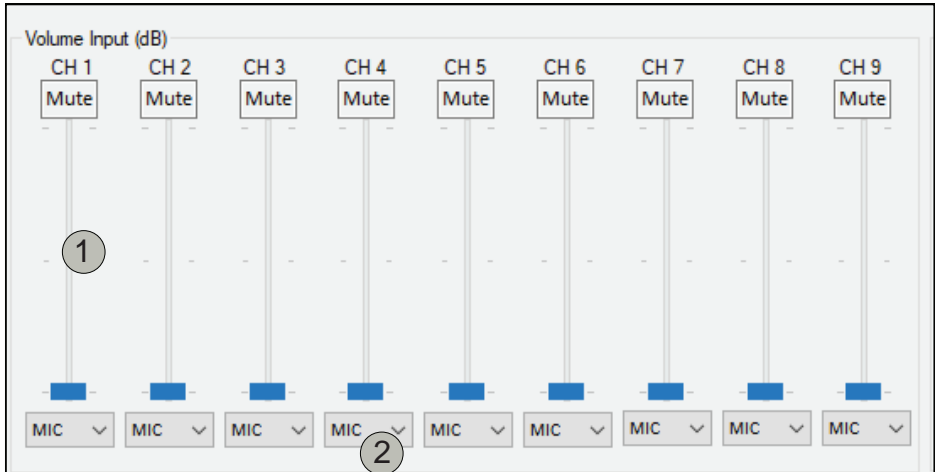
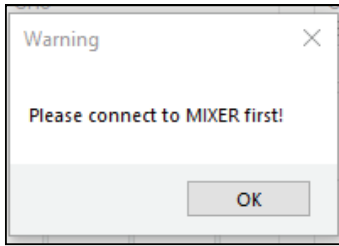

Volume input settings :

1. Volume bar settings :
Users can adjust the volume of each channel with the input range 0 dB max to mute. There is a level input indicator above the volume bar.
2. Input selector :
Users can choose input sources according to user needs. Below are option that can be used for each channel :
 Channel 1 - 4 : Microphone (-55 dB)
 Channel 5 : Microphone (-55 dB; Phone jack), AUX (0 dB; RCA jack)
 Channel 6 - 8 : Microphone (-55 dB), Line (0 dB)
 Channel 9 : Microphone (-55 dB), Phone Streaming (0 dB)
 All channel have mute option.
3. Tone Control settings :
Users can set the tone control for each channel (Bass, Middle and Treble), maximum boost +13 dB, maximum cut -13 dB.

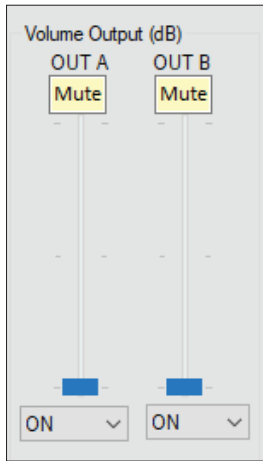

Volume Master (Output) Settings :

1. Volume master settings :

There are 2 output, users can adjust volume each output with range 0 dB max to mute. There is a level output indicator above the volume bar.

2. Output settings :

User can do toggle mute/unmute for each output.

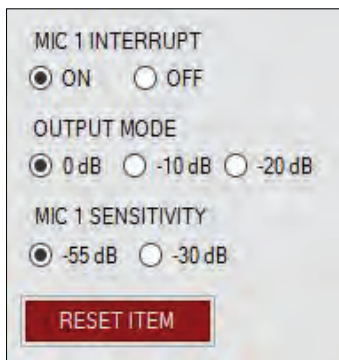

Other Settings :

Users can adjust setting for mic 1 interrupt, output mode and mic 1 sensitivity.

RESET ITEM :

- All volume input and output on minimum
 - All CH tone control flat (0 dB)
 - All CH input are MIC
 - All CH effect are Bypass
 - Other setting MIC 1 Interrupt is ON, Output mode is 0 dB and MIC 1 sensitivity is -55 dB
- message "Load All Data Complete" is appear.
(note : don't click any button during factory preset process)

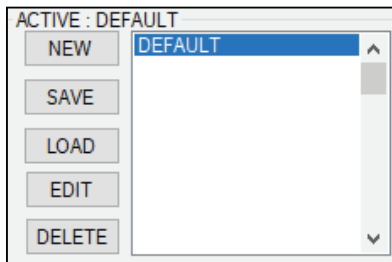

Item Name List :

Mixer can store 50 items in the memory, The active item in the list panel will be highlighted User can do a lot of settings using PC.

1. Add setting item :

Click NEW button then insert item name. Wait until "Item Name [item name] Created " message appear.
(note : If message is not appear user can repeat step from beginning).

New item name will be appear on list but its not highlighted mean that its not active yet.

User can add items up to 50 items setting.

2. Save setting :

Click SAVE button to save setting parameter. Wait until "Item Name [item name] Saved" message appear.
(note : If message is not appear user can repeat step from beginning).

3. Load setting :

Select item name on list and click LOAD button to load setting.

(note : user can also double click on item name on list to load it).

Wait until "Load All Data Complete " message appear.

(note : If message is not appear user can repeat step from beginning)

4. Edit/Rename item name :

Select item name on list and click EDIT button. Insert new item name.

Wait until "Item Name [old item name] Rename to [new item name]."

(note : If message is not appear user can repeat step from beginning)

5. Delete item name :

Select item name on list and click DELETE button.

(note : user cannot delete current active item).

Wait until "Item Name [item name] Deleted".

(note : If message is not appear user can repeat step from beggining)

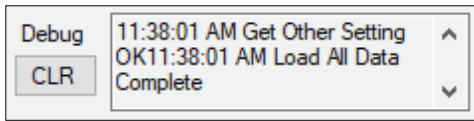

Debug box

User can see on text box to see log activity between mixer and PC.

Click CLR button to clear text box.



Disconnect

Click DISCONNECT button to disconnect from mixer.

9. UPDATE FIRMWARE

MX-9200-AS has an updated firmware function with USB on the rear panel.

So users can update the latest firmware by following the instructions in this document.

update firmware function

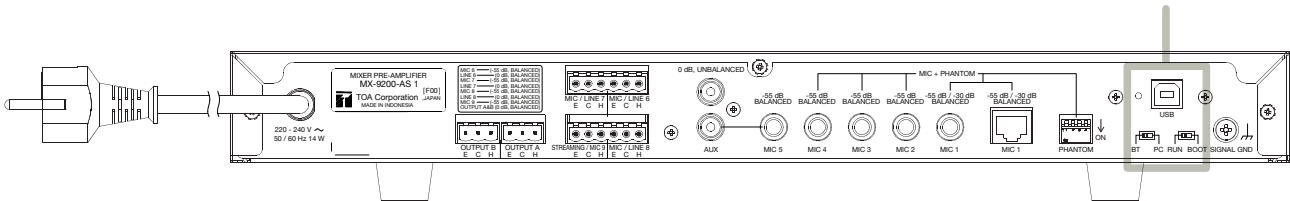

First, in the power Off condition, please set slide switch on the rear panel, switch 1 to the PC and switch 2 to the BOOT. And make sure your computer connected to USB on the panel and then turn On the power switch. In this condition, only the power light is on. Other indicators and the LCD backlight will turn off.

Then open the Flash Loader Demonstrator that has been installed on your computer. The appearance will look like the image below.

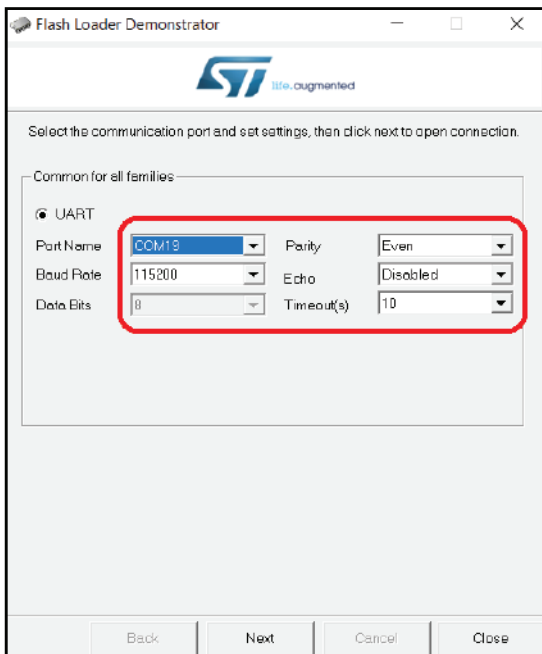

Please adjust the parameter settings according to the picture above. Port Name depends on the settings on your computer, so it might be that the Port Name Parameter does not match the picture above, and that is not a problem.

Then click Next and will show the menu like image below:

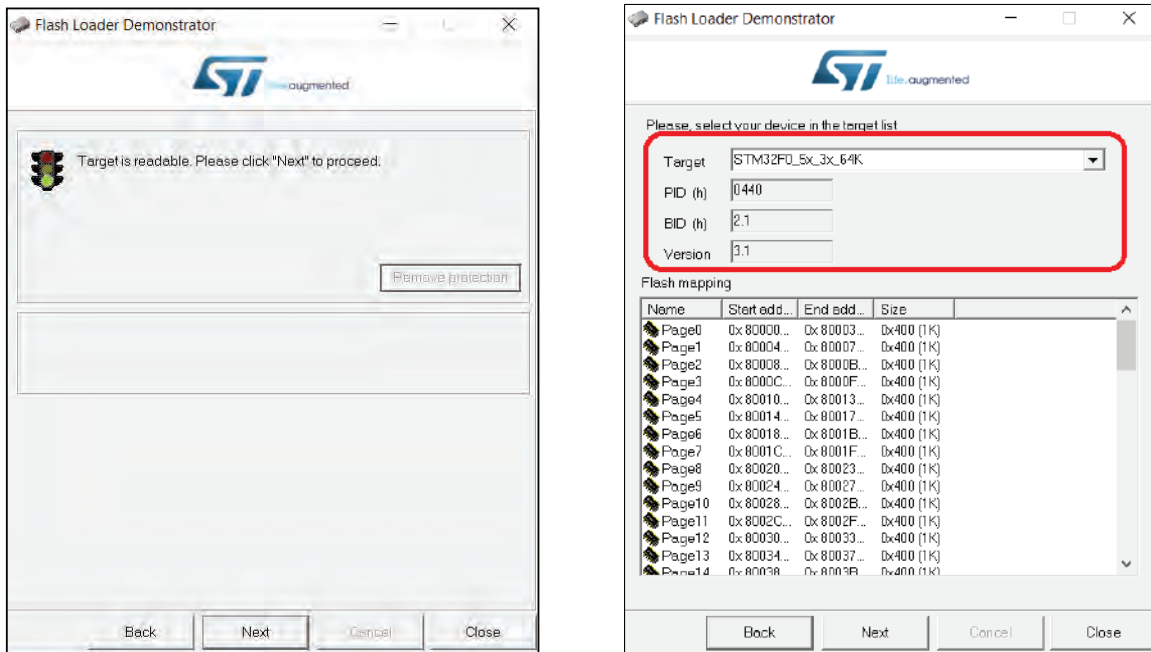

Make sure the target selection like image above, and then press Next

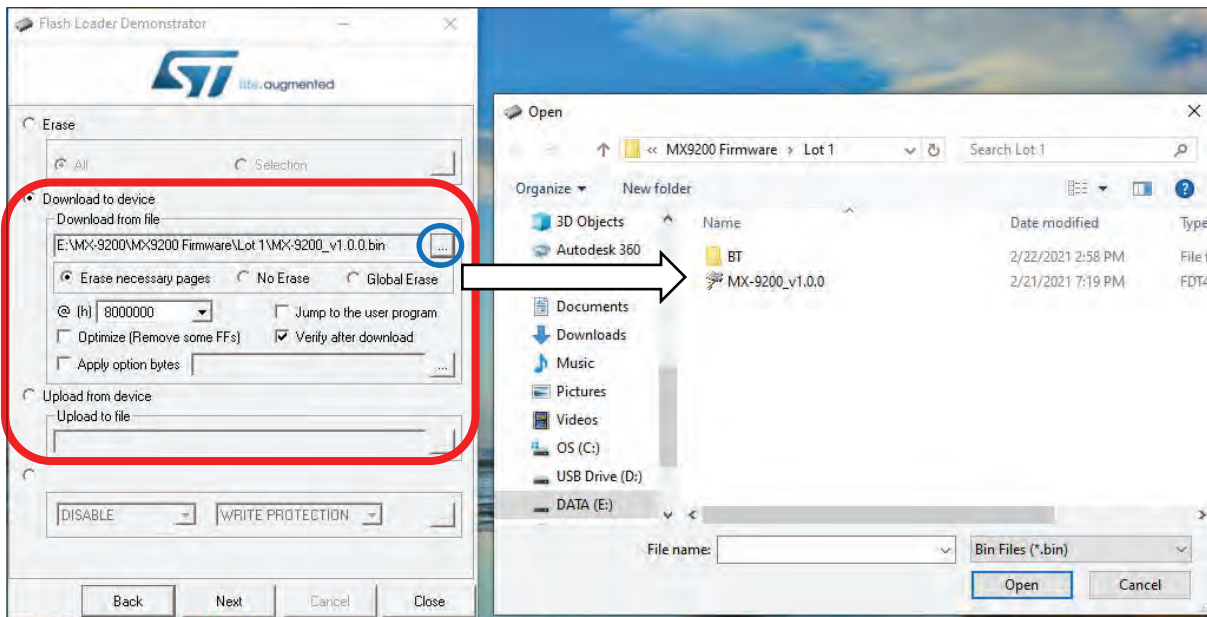

Select "Download to device" then press the box ... (circled in blue) then a file browser popup will appear. Search for firmware on your computer (set file type .bin) and select file "MX-9200_v1.0.0" or a newer version then press OK. Please set other parameters as shown above (circled in red) then press next.

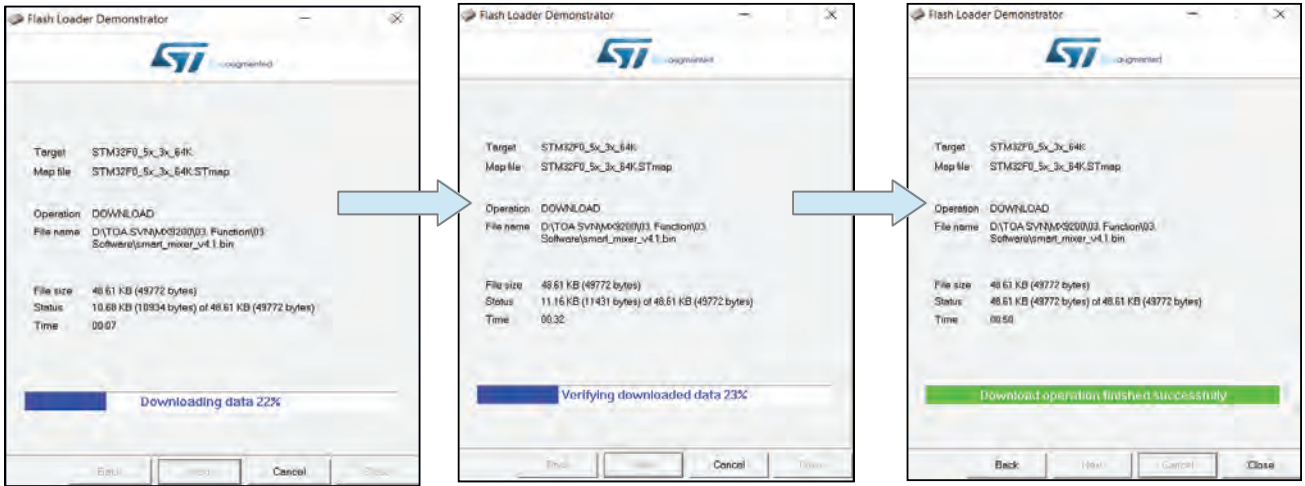

Finally updated firmware completed. Turn Off the panel and set switch on the rear panel back to normally (switch 1 = BT and switch 2 = Run). Then turn On the panel, and MX-9200-AS will running normally

10. DIMENSIONAL DIAGRAM

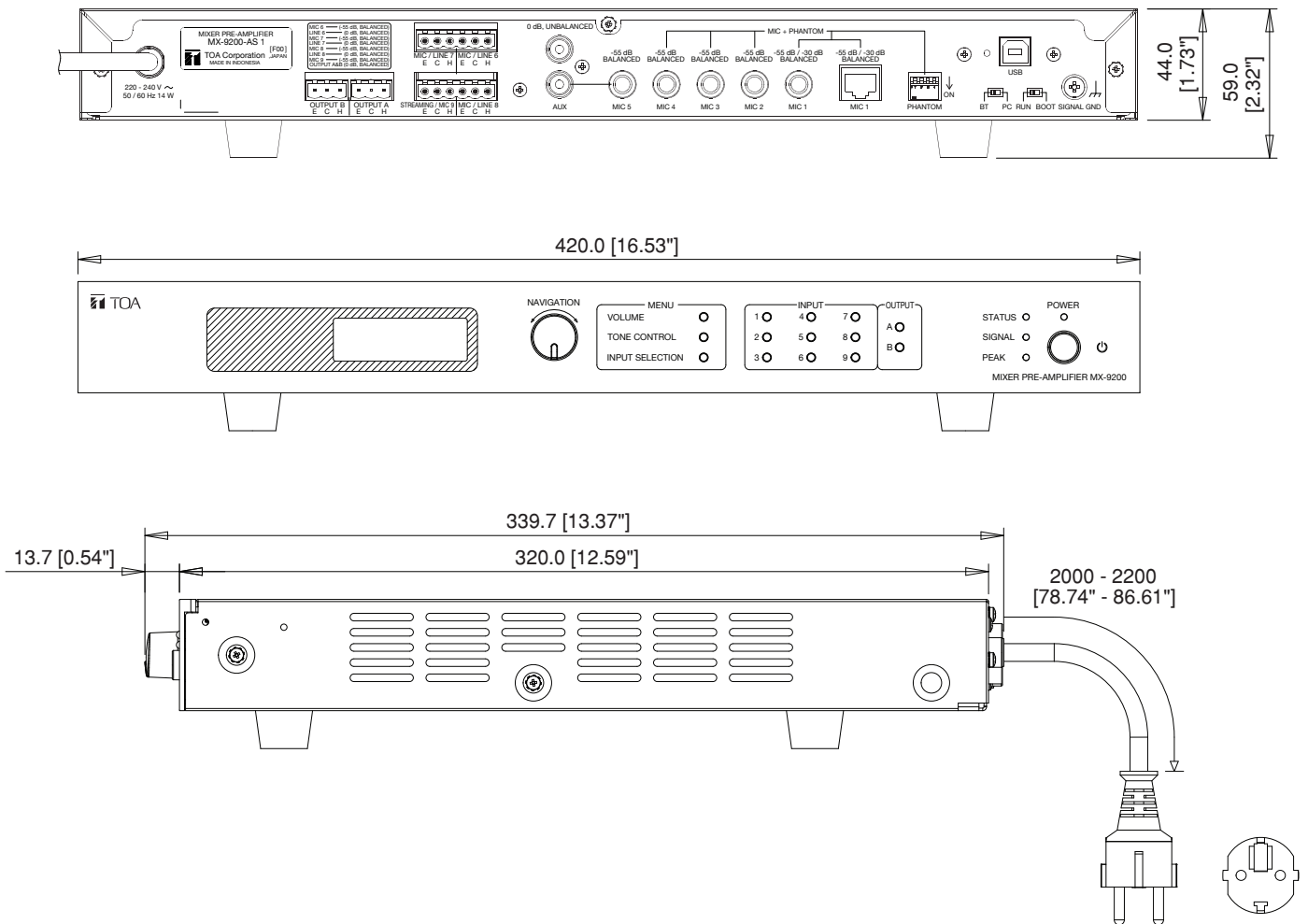

11. SPECIFICATION

Power Source	AC 220 - 240 V, 14 W
Audio Input	<p>Input CH 1 with Phantom option 19 V DC :</p> <ul style="list-style-type: none"> - CHIME MIC : Balanced, Selectable sensitivity -55 dB (1.8 mV)/-30 dB (30 mV), 2.2 kΩ rated 1 kHz, RJ45 connector - MIC : Balanced, Selectable sensitivity -55 dB (1.8 mV)/-30 dB (30 mV), 2.2 kΩ rated 1 kHz, Phone jack connector <p>Input CH 2 - 4 with Phantom option 19 V DC :</p> <ul style="list-style-type: none"> - Balanced, Sensitivity -55 dB (1.8 mV), 2.2 kΩ, rated 1 kHz, Phone jack connector <p>Selectable Input CH 5 with options :</p> <ul style="list-style-type: none"> - MIC : Balanced, Sensitivity -55 dB (1.8 mV), 2.2 kΩ, rated 1 kHz, Phone jack connector - AUX : Unbalanced, Sensitivity 0 dB, 10 kΩ, rated 1 kHz, RCA jack connector <p>Selectable Sensitivity Input CH 6 - 8, Removable terminal 3 pins with sensitivity options :</p> <ul style="list-style-type: none"> - LINE : Balanced, Sensitivity 0 dB, 2.2 kΩ, rated 1 kHz - MIC : Balanced, Sensitivity -55 dB (1.8 mV), 2.2 kΩ, rated 1 kHz <p>Selectable Sensitivity Input CH 9, Removable terminal 3 pins with sensitivity options :</p> <ul style="list-style-type: none"> - MIC : Balanced, Sensitivity -55 dB (1.8 mV), 2.2 kΩ, rated 1 kHz - STREAMING : Unbalanced, Sensitivity 0 dB 10 kΩ, rated 1 kHz
Audio Output	<p>Audio OUT A & B, Balanced, Removable terminal 3 pins</p> <p>Optional output level : 0 dB/-10 dB (300 mV)/-20 dB (100 mV), 600 Ω, rated 1 kHz</p>
Control Output	<p>9 Shortcut switch IN, 2 Shortcut switch OUT, 1 Shortcut switch VOLUME, 1 Shortcut switch Tone Control, 1 Shortcut switch Input Selection, 1 Navigation switch (Right, Left, Push)</p>
Tone Control	Bass \pm 13 dB at 100 Hz, Middle \pm 13 dB at 1 kHz, Treble \pm 13 dB at 10 kHz
Distortion	Under 1% at 1 kHz, rated power
Frequency Response	30 Hz - 20 kHz, \pm 3 dB
Indicator	LCD display with backlight green, POWER indicator light green, STATUS indicator light green, SIGNAL indicator light green, PEAK indicator light red
Connection	Bluetooth 4.2, USB Type B (PC Setting/Update Firmware)
Operation Temperature	0°C to +40°C
Operation Humidity	Under 90% RH (no condensation)
Finish	Front Panel : Aluminum Hair Line, Painting Black Case : Steel Plate, Painting Black
Dimensions	420 (W) x 59 (H) x 339.7 (D) in mm (16.53" x 2.32" x 13.37")
Weight	3.5 kg
Accessories	6P Connector ...2 3P Connector ...2

* 0 dB = 1 V

Notes :

- The design and specifications are subject to change without notice for improvement.
- Optional product
Rack - mounting bracket : MB-15B